

R PV 17

SC-TM-69-298

CALORIMETERS FOR MEASURING HIGH-ENERGY,
HIGH-INTENSITY, PULSED ELECTRON BEAMS

J. F. Schulze
Radiation Source Diagnostics Division, 5223*
Sandia Laboratories, Albuquerque

June 1969

ABSTRACT

Calorimetry represents a reliable method of defining high-intensity electron beams associated with pulsed machines such as Hermes I and Hermes II. Described here are methods and techniques sufficient for the design of both linear array and total stopping calorimeters. Additionally, experimental data obtained on Hermes I are presented to demonstrate the utility of the method.

* Formerly Division 9113.

TABLE OF CONTENTS

	<u>Page</u>
Introduction	5
Linear Array Calorimeters	5
Total Stopping Calorimeters	10
Planar Array of Total Stopping Calorimeters	11
Design Calculations for Calorimeter Fabrication	13
Representative Results	14
Summary	15
LIST OF REFERENCES	17
APPENDIX -- CALORIMETER CALIBRATION CURVES AND MATERIAL PROPERTIES	19

LIST OF ILLUSTRATIONS

<u>Figure</u>		
1.	Graphite Linear Array Calorimeter	6
2.	Damaged Graphite Linear Array Calorimeter	6
3.	Equilibrator	7
4.	Miscellaneous Thermocouple Joining Techniques	8
5.	Damaged Tantalum Linear Array Assembly	9
6.	Titanium Linear Array Assembly	10
7.	Infinite Calorimeter Assembly	11
8.	Planar Array	12
9.	Representative Results from Graphite Linear Array	15

LIST OF ILLUSTRATIONS (cont)

<u>Figure</u>		<u>Page</u>
10.	Graphite Calorimeter Absorbed/Incident Energy Versus Output	21
11.	Calorimeter Output Versus Absorbed Energy ("Thin" Ti Calorimeters - Cr-Al Junction 124 gm/cm ² Thick)	21
12.	Absorbed Energy-Output ("Thin" Al Calorimeters - Cr-Al Junctions)	22
13.	Tantalum Calorimeter Calibration	23
14.	Specific Heat - Graphite Grade 7087	23
15.	Specific Heat - Graphite Grade 3474D	24
16.	Specific Heat - Graphite Grade ATJ	24
17.	Specific Heat - Aluminum	25
18.	Thermal Conductivity - Aluminum	25
19.	Specific Heat - Titanium	26
20.	Thermal Conductivity - Titanium	26
21.	Thermal Linear Expansion - Titanium	27
22.	Specific Heat - Copper	28
23.	Thermal Conductivity - Copper	28
24.	Specific Heat - Molybdenum	29
25.	Thermal Conductivity - Molybdenum	29
26.	Specific Heat - Tantalum	30
27.	Thermal Conductivity - Tantalum	30

CALORIMETERS FOR MEASURING HIGH-ENERGY, HIGH-INTENSITY, PULSED ELECTRON BEAMS

Introduction

The purpose of this memorandum is to present the progress that has been made in the fabrication of calorimeters that will withstand the high-intensity, pulsed electron beams produced by Hermes I and Hermes II. It is no easy task to make linear array calorimeters (stacks of individual, partially absorbing calorimeters used to measure dose-depth profiles) that will withstand 100 calories per square centimeter. On the other hand, making total stopping calorimeters of graphite to withstand doses as high as 200 calories per square centimeter is comparatively easy.

We will discuss early efforts, current efforts, and proposed future efforts along with typical results obtained on Hermes I. Major problem areas have been materials and bonding fixtures which deteriorate rapidly as beam energy density is increased.

Some of the material properties information that was collected is presented along with computational methods needed to fabricate calorimeters for specific problems. More detailed information concerning the use of calorimetry for electron beam diagnostics can be found in Reference 1.

Linear Array Calorimeters

The first calorimeters were made from graphite discs 43 mils thick. These were plated on the edge with copper and then mounted into a phenolic

rod with slots cut into the rod approximately 50 mils deep and spaced 40 to 50 mils apart. Leads of 5-mil chromel-alumel were silver-soldered to the plated copper edge, fed through a small hole drilled through the back of the phenolic rod, and attached to a plug (Figure 1). The discs were then epoxied in place with some Pittsburgh plate-glass-type 777 Bondmaster epoxy.

Almost all of the initial work was done with graphite which stands up well. Graphite does not spall or melt at low temperatures, has a very low expansion coefficient ($7.8 \times 10^{-6}/^{\circ}\text{C}$), and is also a good thermal and electrical conductor.

This graphite calorimeter finally disintegrated as is shown in Figure 2. Most of the heat was concentrated in the second disc as would be expected. The epoxy deteriorated; enough heat was deposited in the second disc so that the silver solder melted and splattered onto the wall of the equilibrator (Figure 3).

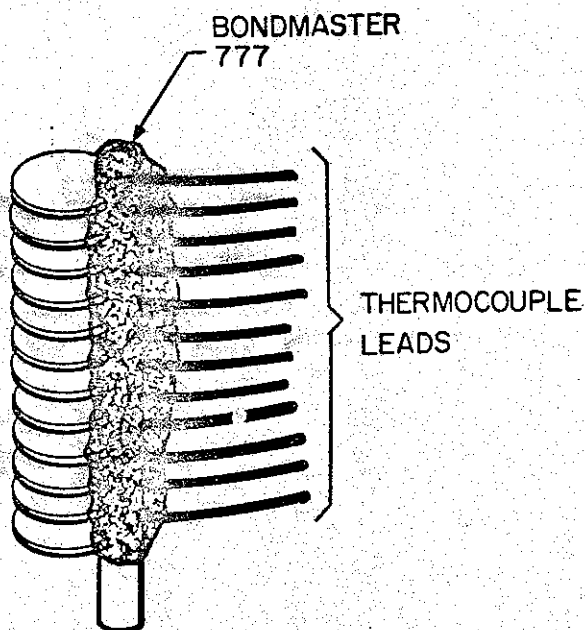

Figure 1. Graphite Linear Array Calorimeter

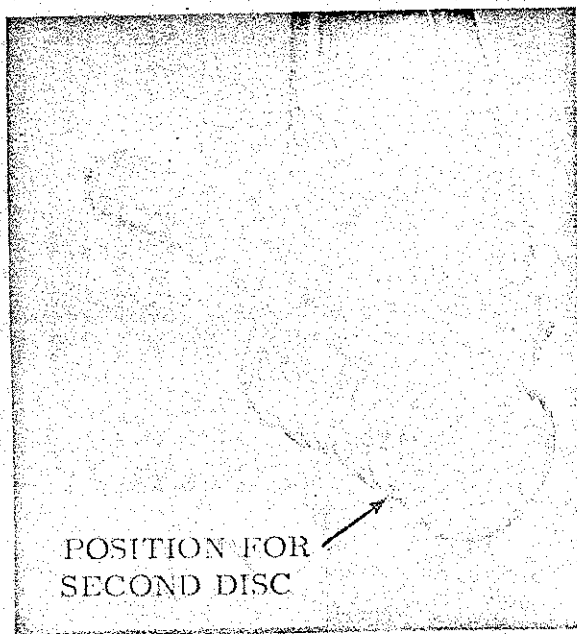

Figure 2. Damaged Graphite Linear Array Calorimeter

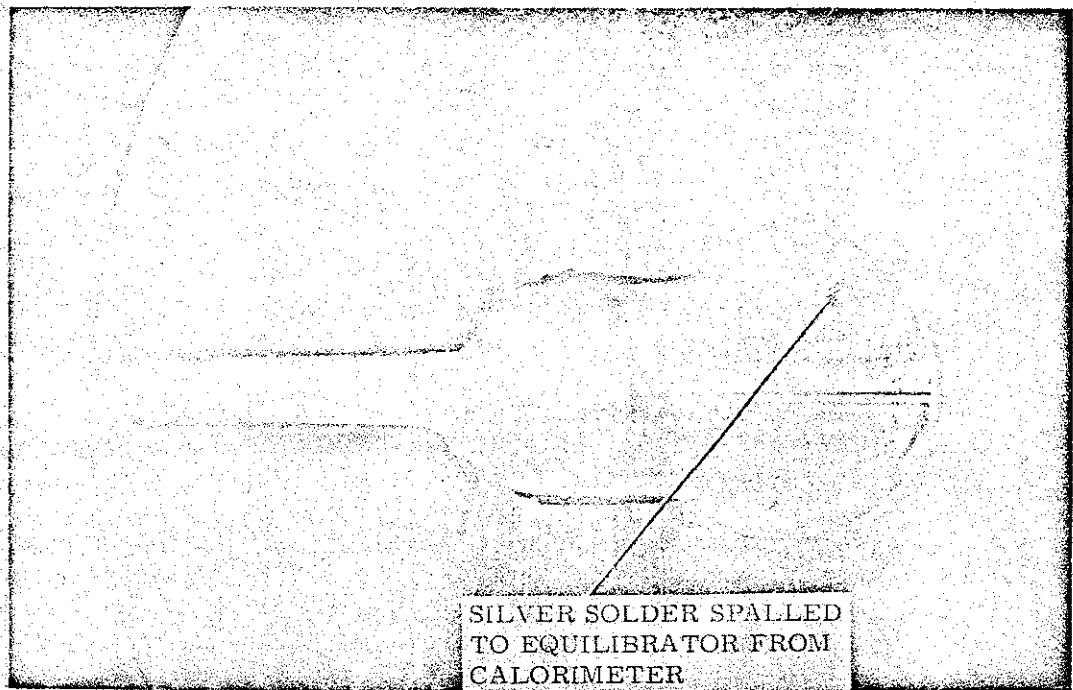

Figure 3. Equilibrator

Another early design for a linear array calorimeter was aluminum; the basic procedure for fabrication remained the same except, in order to fasten the leads onto aluminum, resistance welding had to be employed. Since the thermocouple leads are 5 mils in diameter and the aluminum discs are 30 mils thick, it was not possible to get a good bond because the aluminum dissipates heat so fast, and the bonds were found to fail when subjected to beam energy densities on the order of 30 cal/cm^2 . This problem may be solved by boring 8-mil holes into the edge of the aluminum disc and peening the leads into it. However, when subjecting this calorimeter to higher beam energy density (about 40 to 50 cal/cm^2), the second disc in the stack spalled very badly and the first was blown off although less spalling took place. The third calorimeter disc also spalled but to a lesser degree; it was still intact after the shot.

As indicated earlier, the next logical step was to employ a material with a high melting point in order to produce a linear array calorimeter that would be capable of measuring beam energy densities of about 100 cal/cm^2 .

A tantalum linear array was built with the thermocouple leads attached to the face close to the edge of each 5-mil-thick disc. (See pretest geometry in Figure 4.) Thermocouple leads resistance-weld to tantalum with comparative ease, due to its high melting point and low thermal conductivity, and hold with amazing strength. The tantalum linear array calorimeter did not operate adequately at beam energy densities of about 30 cal/cm^2 due to radiation heat transfer losses but did remain intact. Ultimately, when exposed closer to the pinch point (about 50 to 60 cal/cm^2), the tantalum curled and broke away from its bond. The leads stayed attached except for the first one which was blown completely off (Figure 5).

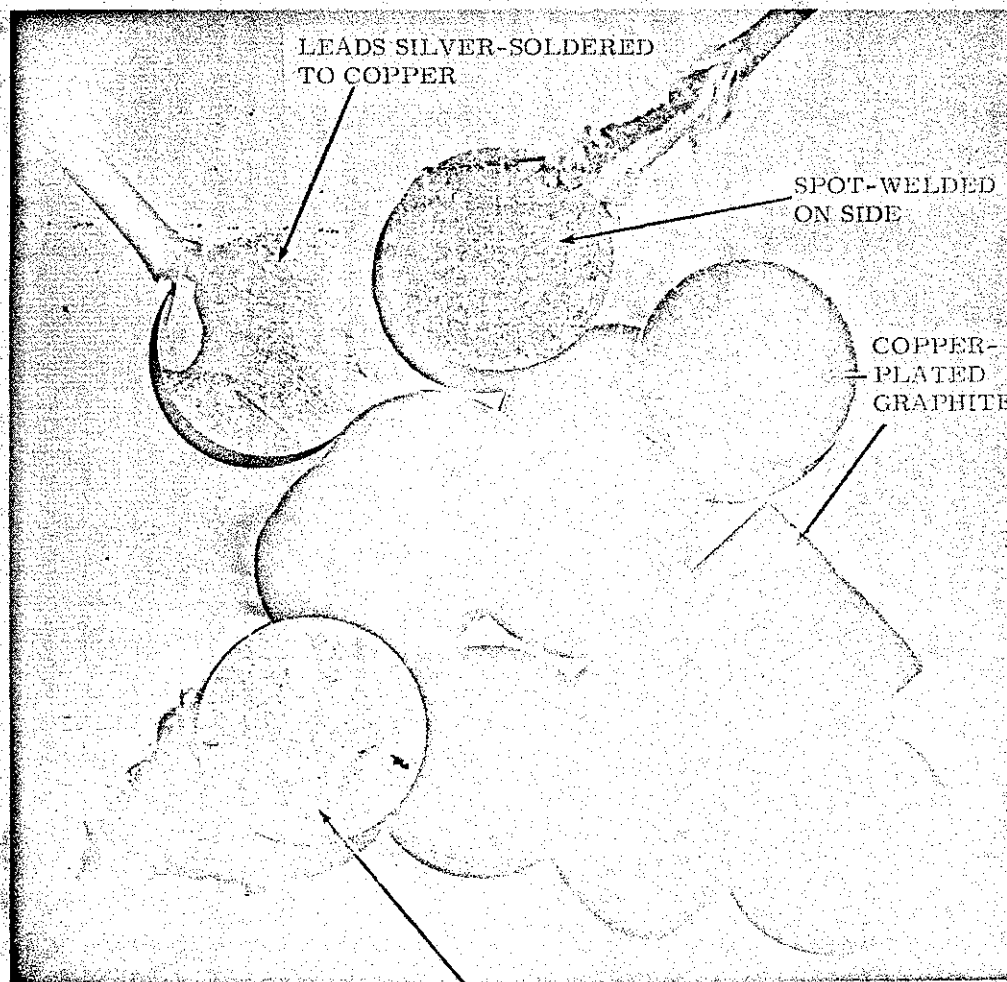

Figure 4. Miscellaneous Thermocouple Joining Techniques

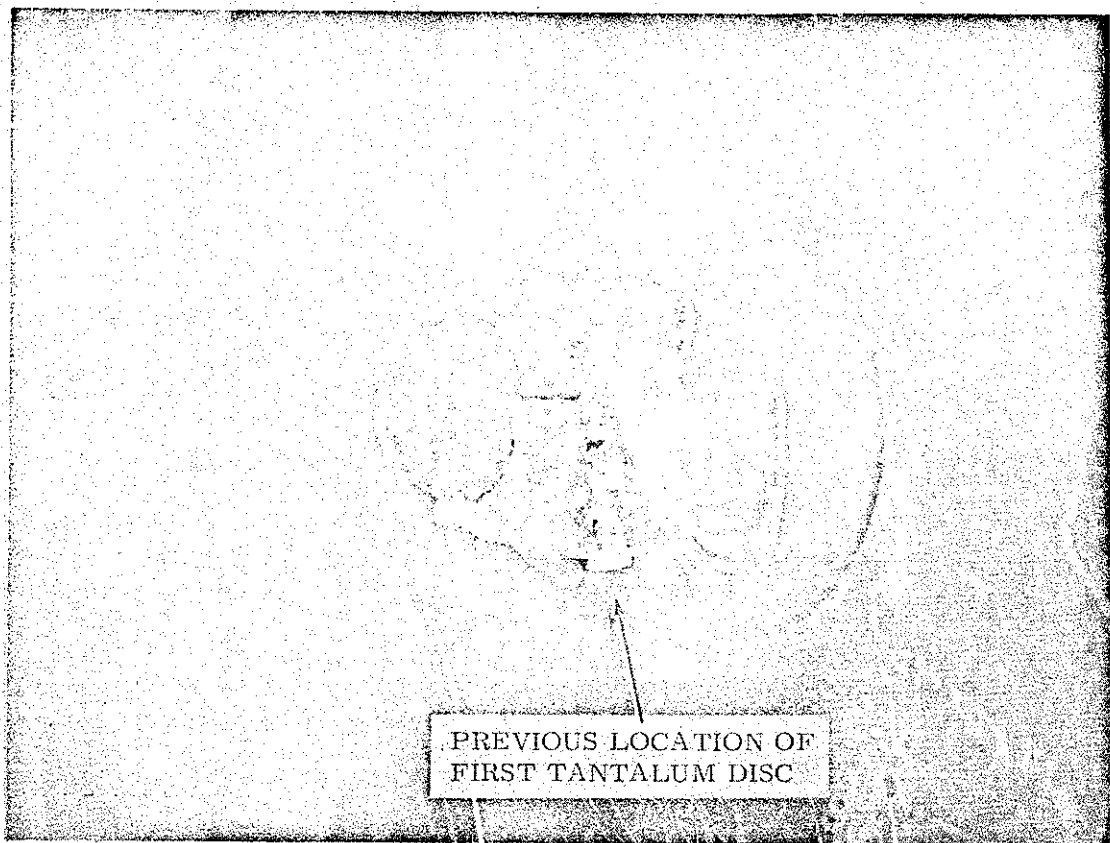

Figure 5. Damaged Tantalum Linear Array Assembly

On the basis of published material properties, perhaps the best calorimeter material for high-intensity measurements should be titanium. The metal has a high melting point (1675°C), good thermal conductivity, high tensile strength, and is easy to resistance-weld to thermocouple materials. It should be pointed out that in the latest design we drilled holes in the edge of the calorimeter for the thermocouple leads. In Figure 6 a finished titanium linear array assembly in its equilibrators is shown after a 30 cal/cm^2 shot from Hermes I. The array is raised slightly to show fabrication.

When subjecting the titanium linear array to the electron beam, a beam energy density of 60 cal/cm^2 was measured before failure of the calorimeter array occurred. All thermocouple leads were still connected but the epoxy was shattered and the phenolic rod which held the 12 discs (unmarred) literally disintegrated.

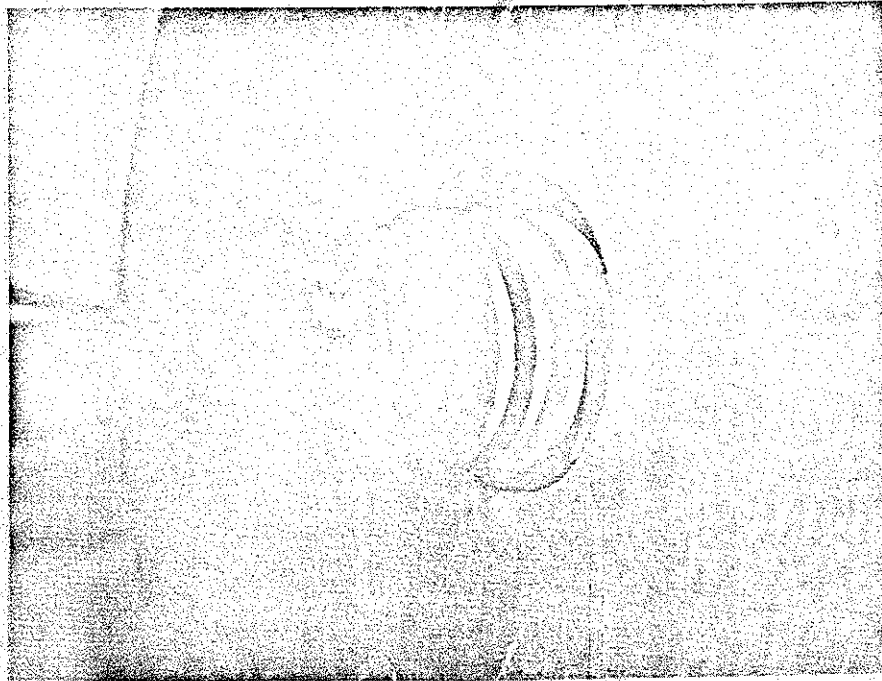

Figure 6. Titanium Linear Array Assembly

Total Stopping Calorimeters

Making infinite-thickness calorimeters, those which totally stop electrons of a given energy, is a much easier task. Usually the thermocouple leads will be fixed to the rear of the calorimeter. The easiest method of attachment to most materials is to drill 8-mil-diameter holes at an acute angle to the back surface (Figure 7) and then peen the leads of the thermocouple wire into place. The degree of difficulty in thermocouple attachment will depend on the material involved; i. e., it is much easier to drill holes into such materials as aluminum whereas others such as tantalum can become quite difficult to drill, especially if the calorimeter disc is fairly thin. In the case of a thin calorimeter disc, it may become necessary to electron-beam-weld the leads to the disc or perhaps resistance-weld them to the disc. The method of thermocouple attachment is a case of individual judgment when dealing with different calorimeter materials and configurations.

Mainly it is advisable to try to mount all thermocouple leads into holes since this method results in the strongest bond. In the case of graphite, another approach is needed since peening of graphite is, of course, not feasible.

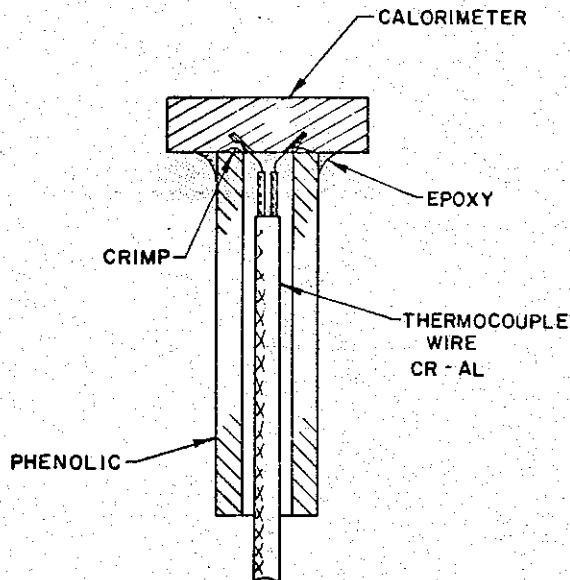

Figure 7. Infinite Calorimeter Assembly

On graphite calorimeters of the infinite-thickness variety, we have found only one way to attach thermocouple junctions--by plating the back of the calorimeter with copper 4 to 8 mils thick and then silver-soldering the thermocouple leads onto this surface. If the silver-soldering is done correctly, it is possible to attach leads with an approximate point contact, thus avoiding a large mass of silver solder to dissipate heat. It is advisable to put a small drop of epoxy on the finished weld for strength (Figure 7).

Planar Array of Total Stopping Calorimeters

By spacing total stopping calorimeters throughout an equilibrator of like material, it is possible to devise an effective, but low spatial resolution, detector for determination of spatial variations in the electron beam energy density profile. The geometry of the calorimeters and the placement throughout the equilibrator can be tailored to the specific measurement required.

Calorimeters of this type made of graphite have been used to measure in excess of 300 cal/cm^2 with no apparent damage to the calorimeters although certain steps were necessary to insure nondamage to the total array. A very successful configuration that can be adapted to various calorimeter placements is pictured in Figure 8. The typical size used was 1 square centimeter by 0.520 inch in length which is totally absorbing for 4-meV

electrons. After the leads were attached, a 1/4-inch phenolic tube was epoxied to the rear of the calorimeter and then mounted into a phenolic board which was mounted into the rear of the graphite equilibrator. This procedure insures that the calorimeter electrically "floats" from the equilibrator and heat loss is minimized (Figure 8).

By making very small calorimeters and mounting them close together, i. e., approximately 1/4 inch apart, it is possible to make sophisticated mapping devices which give the beam profile at the position desired.

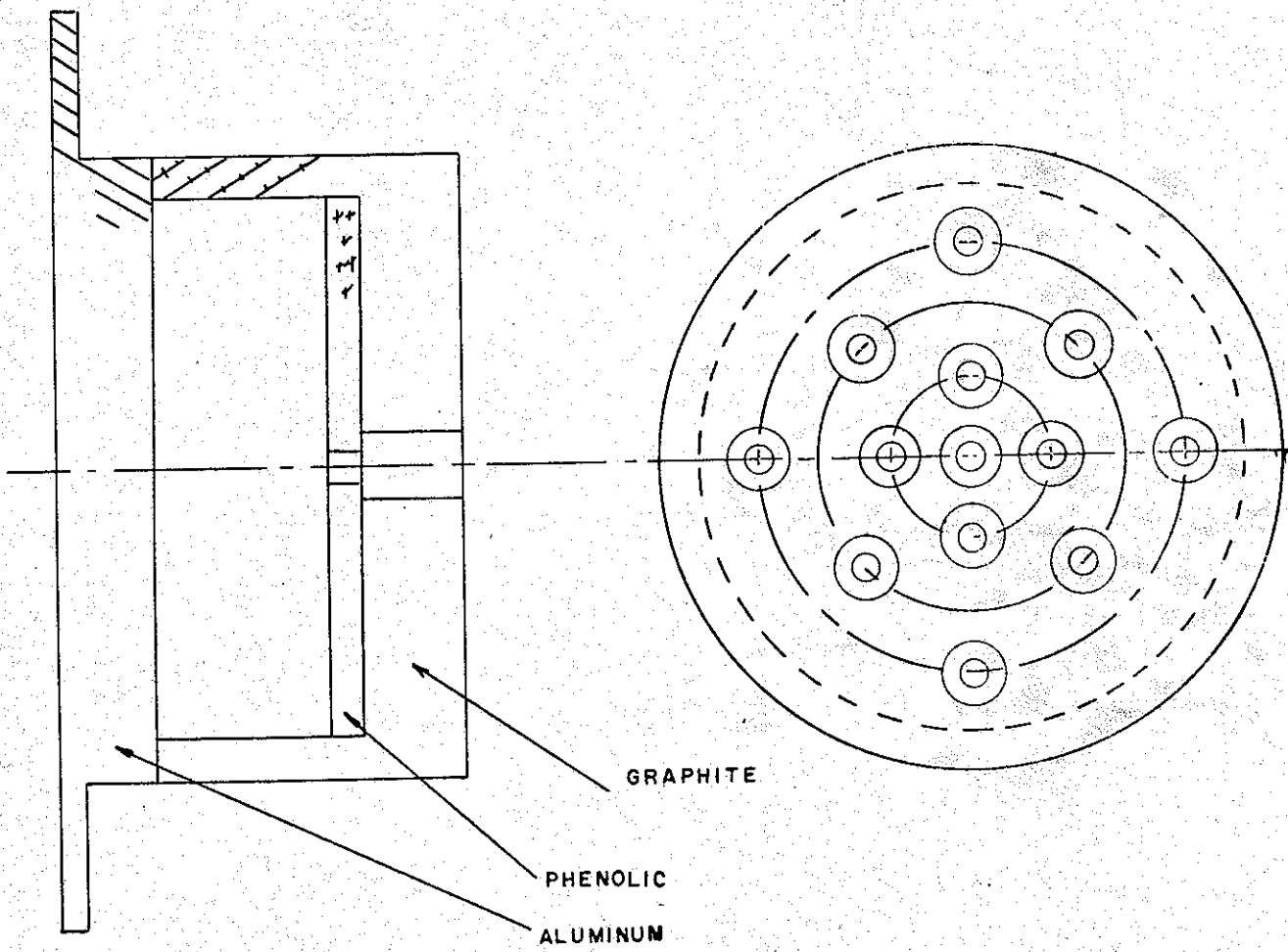

Figure 8. Planar Array

Design Calculations for Calorimeter Fabrication

In order to make sure that one gets the right total thickness of calorimetric material for a given energy electron or a given material, simple calculations are required. The amount of material needed to stop a certain energy electron² must be known along with the density of the material. The range of the electron and the density of the calorimetric material are given in the following units:

$$\text{MeV Range} = \text{gm/cm}^2$$

$$\text{Density} = \text{gm/cm}^3$$

Hence, the linear thickness is simply

$$\frac{\text{Range}}{\text{Density}} = \text{Linear thickness for a certain energy} .$$

An example for 4 MeV (the range versus energy for electrons is given in Reference 2) follows: the range in copper for 4 MeV is 2.68 gm/cm^2 ; the density is 8.92 gm/cm^3 ; thus the linear thickness required is

$$\frac{2.68 \text{ gm/cm}^2}{8.92 \text{ gm/cm}^3} = 0.300 \text{ cm or } 0.118 \text{ inch} .$$

This number is then divided by the number of discs desired, which in our case was 12, which results in 0.0099 inch or, rounded off, 10 mils per disc.

When making the equilibrator, all that is necessary is to make sure the material of the equilibrator is the same as that of the calorimeter so

that scatter characteristics of both are the same. This eliminates the fact that if the two materials are of different densities, scatter of electrons from the equilibrators might affect the reading on the calorimeter or vice versa.

If a direct readout device is used and is calibrated in volts-per-unit deflection, the graphs shown in Figures 10 through 13, included in the Appendix, may be used to determine the incident energy density or absorbed dose. It should be noted that these data present absorbed energy or incident energy density versus thermocouple output for the Hermes I environment. There are also charts of thermal conductivity and specific heat for the more suitable calorimeter materials. Figures 14 through 27 may be used in case one is interested in deciding which material is best for each individual application (Reference 3).

Representative Results

Figure 9 indicates energy absorbed in the Hermes I environment for each individual disc in the graphite linear array. Note that as the beam moves away from the tube face, it becomes more intense, indicating the proximity of the first pinch. At 1-1/2 inches the leads melted away from the first two discs and the second one was destroyed. The reading on the third disc was off scale or in excess of 105 cal/gm. It should be noted in Figure 9 that the points plotted indicate the midpoint of each disc which was 43 mils thick.

Considerably more data indicating the accuracy achieved with the various calorimetry materials and configurations can be found in Reference 1.

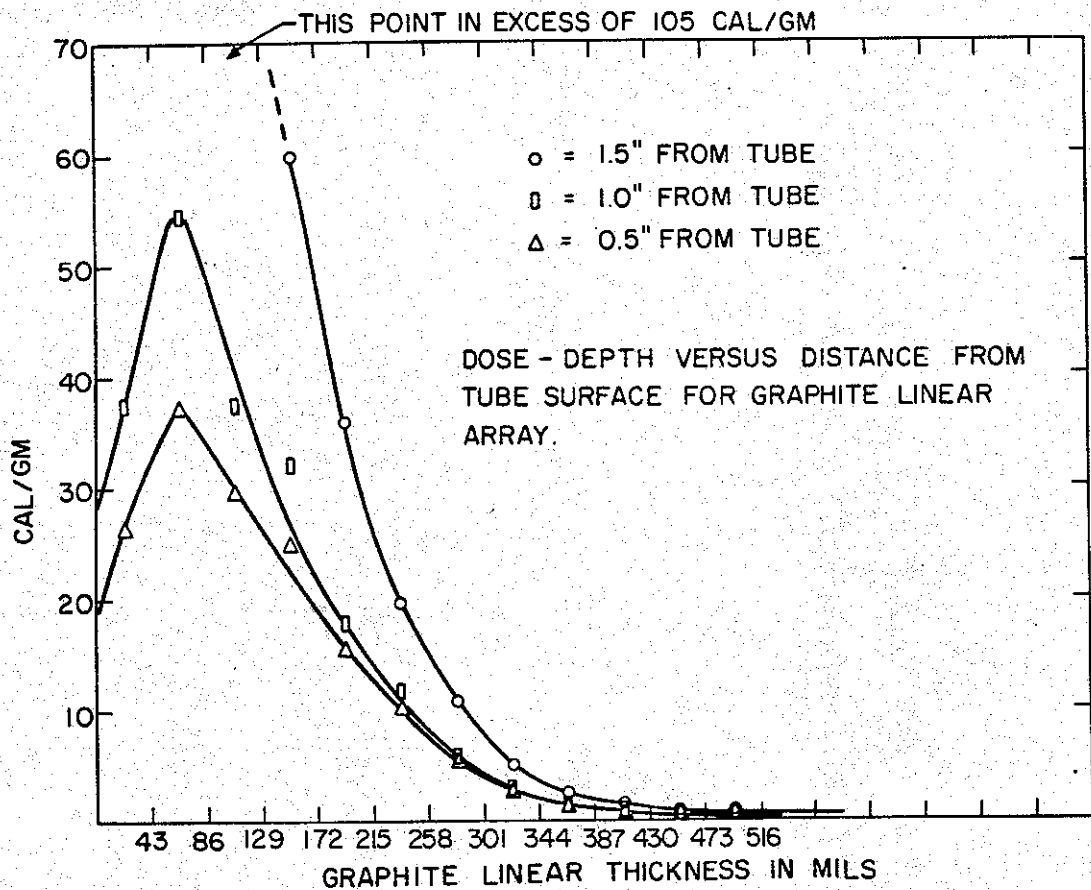

Figure 9. Representative Results from Graphite Linear Array

Summary

At this point one can say that the problems associated with calorimetry do not appear to be insurmountable but additional developmental work on the linear array calorimeters is required in order to get accurate results and structural integrity for high beam energy densities. Once one has solved the problems of disintegration, shock, heat loss, etc., then calorimeters become a reliable means of electron beam diagnostics.

All in all, titanium at this point has proven to be the most useful metal for linear array calorimetry due to its high melting point, low thermal expansion coefficient, and moderate ease in fabrication. The

difficulties encountered in the case of aluminum are presumed to be solved with better bonding between disc and thermocouple wire.

Different materials for support structure in the linear array calorimeters are currently being tried, such as fused silica rings to support each individual disc in the stack with spacing and insulation provided by these rings.

The graphite planar arrays have shown that very accurate mapping can be done with little, if any, damage in relatively dense electron beams. Some new designs in graphite planar arrays have as many as 20 to 50 individual calorimeters in a 1-1/2-inch-diameter circle.

There are many other calorimeter materials that can be tried; corroboration of the present information using more of them in the future is anticipated.

LIST OF REFERENCES

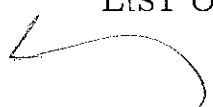
- 
1. Posey, L. D. and Buckalew, W. H., Electron Beam Diagnostics, Sandia Laboratories, Albuquerque (to be published).
 2. Studies in Penetration of Charged Particles in Matter, Publication 1133, National Academy of Sciences - National Research Council, Washington, D.C., 1964.
 3. Touloukian, Y. S., Thermo Physical Properties of High Temperature Solid Materials, Elements, Vol. No. 1, MacMillan, New York, 1967.

part E
Radiation
Production
Note 4
Oct 69

LIST OF REFERENCES

1. Buckalew, W. H. and Posey, L. D., Electron Beam Diagnostics: Part I, Radiation Production Note 4, October 1969.
2. Studies in Penetration of Charged Particles in Matter, Publication 1133, National Academy of Sciences - National Research Council, Washington, D. C., 1964.
3. Touloukian, Y. S., Thermo-Physical Properties of High Temperature Solid Materials, Elements, Vol. No. 1, MacMillan, New York, 1967.

APPENDIX

CALORIMETER CALIBRATION CURVES
AND MATERIAL PROPERTIES

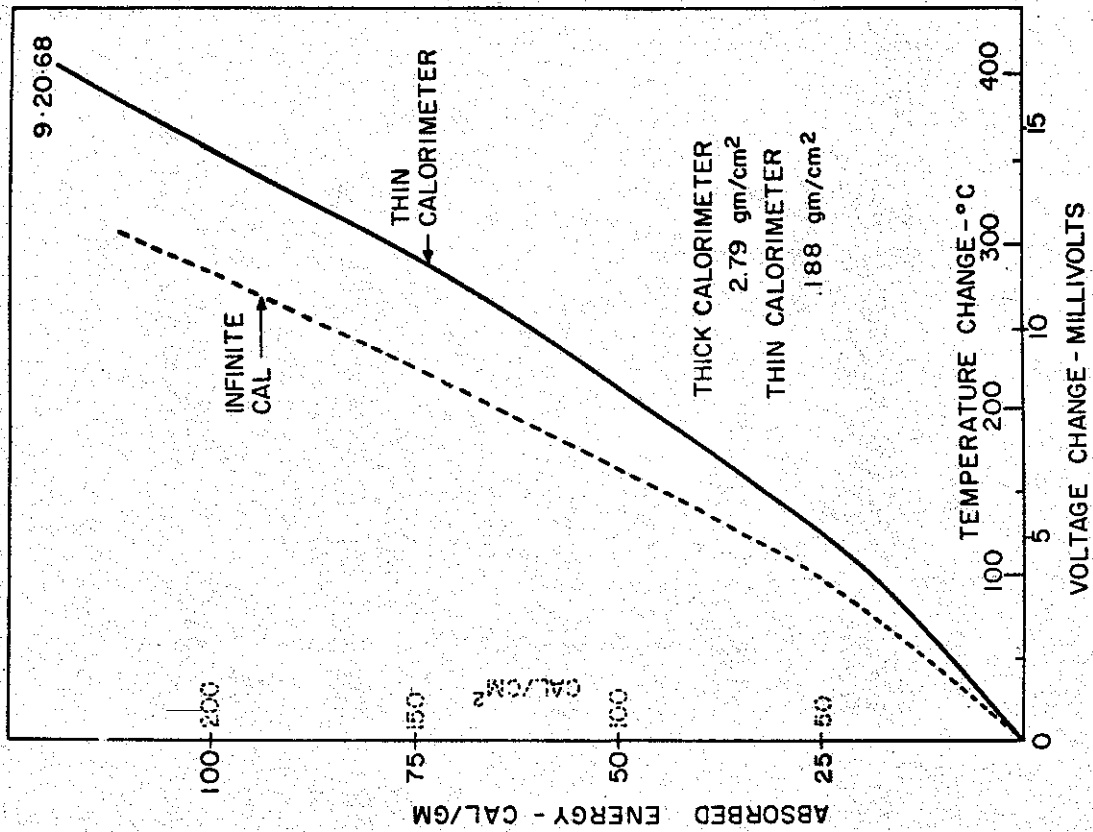

Figure 10. Graphite Calorimeter Absorbed/ Incident Energy Versus Output

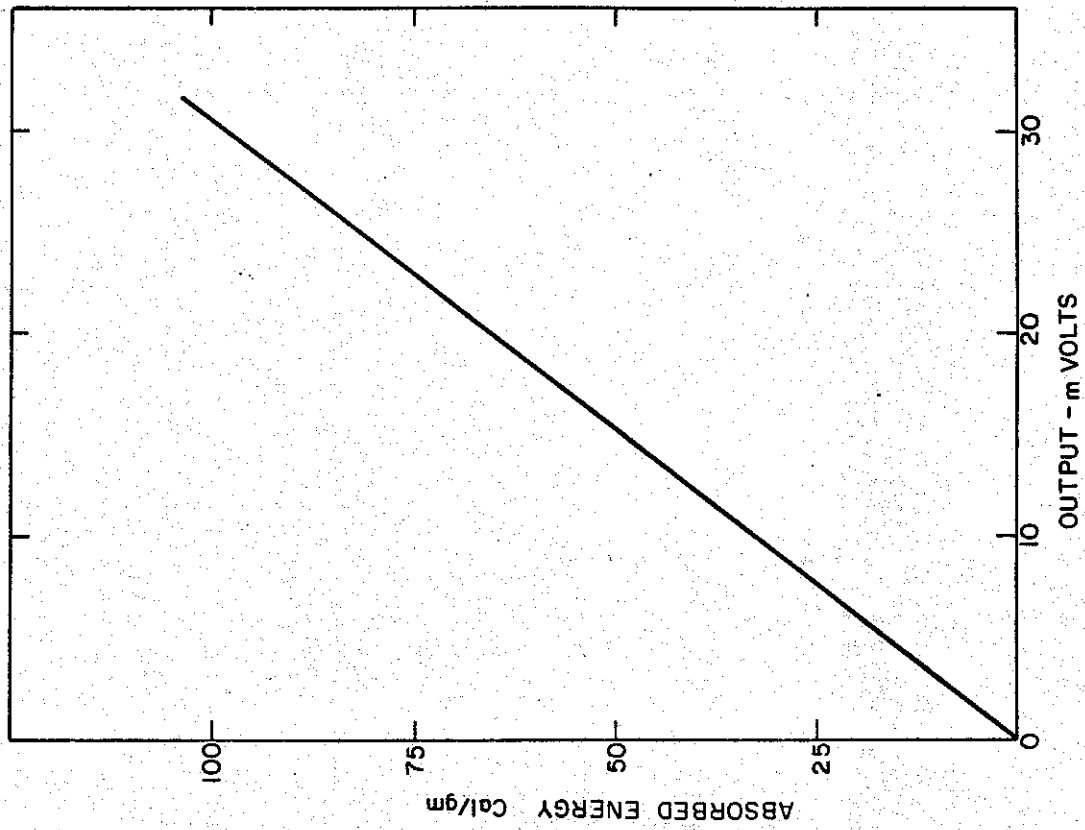

Figure 11. Calorimeter Output Versus Absorbed Energy ("Thin" Ti Calorimeters - Cr-Al Junction)

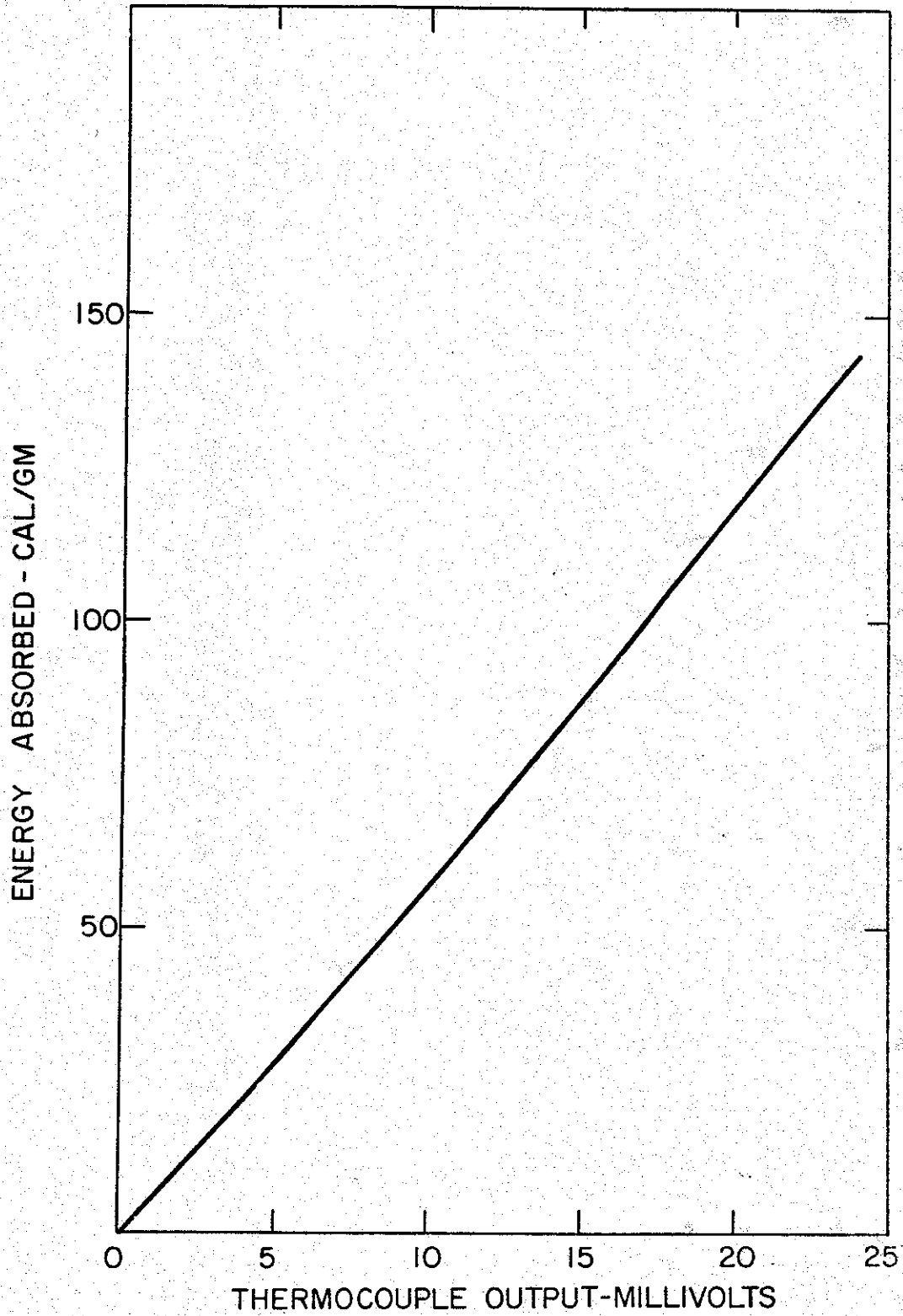

Figure 12. Absorbed Energy-Output ("Thin" Al Calorimeters - Cr-Al Junctions)

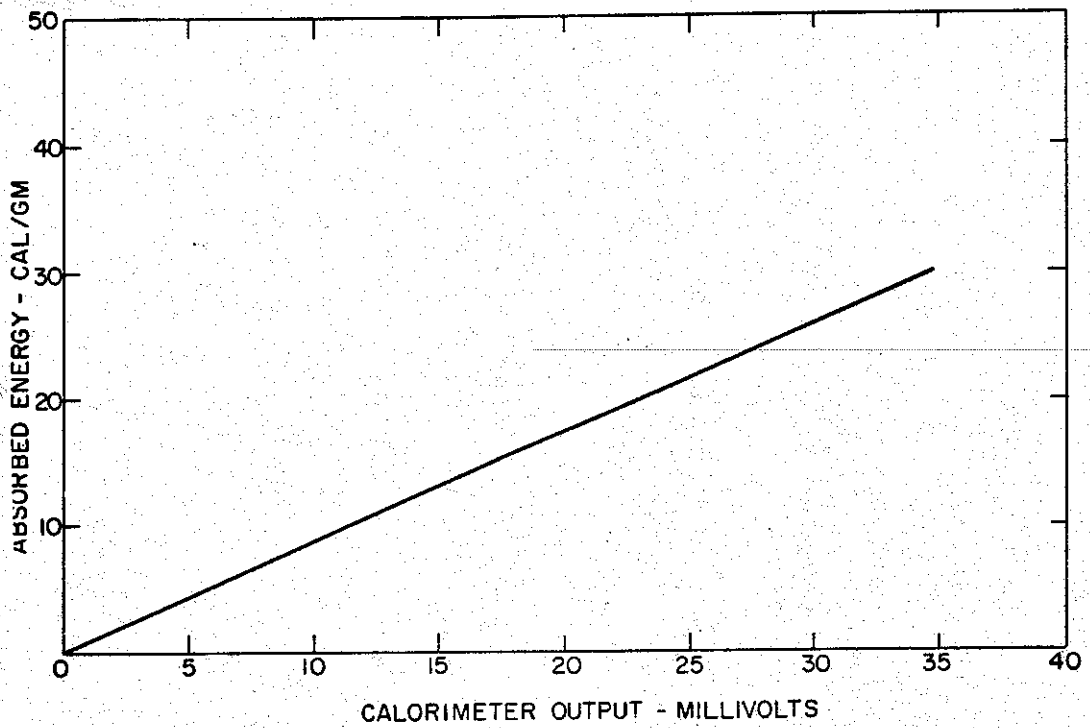

Figure 13. Tantalum Calorimeter Calibration

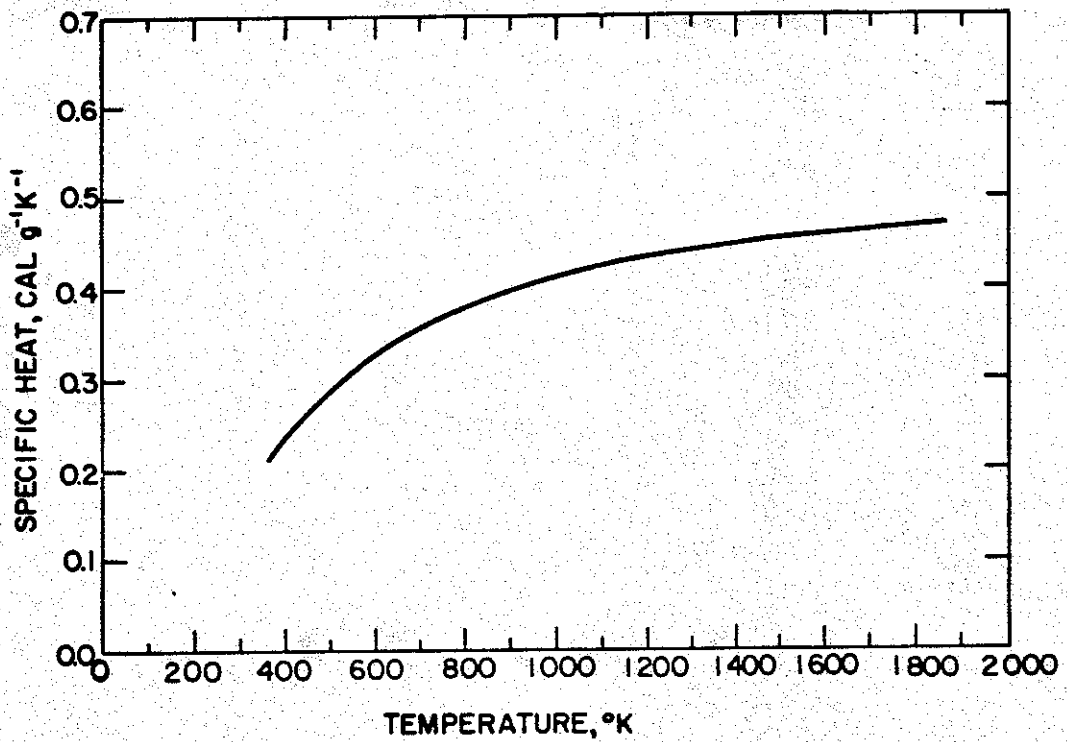

Figure 14. Specific Heat - Graphite Grade 7087

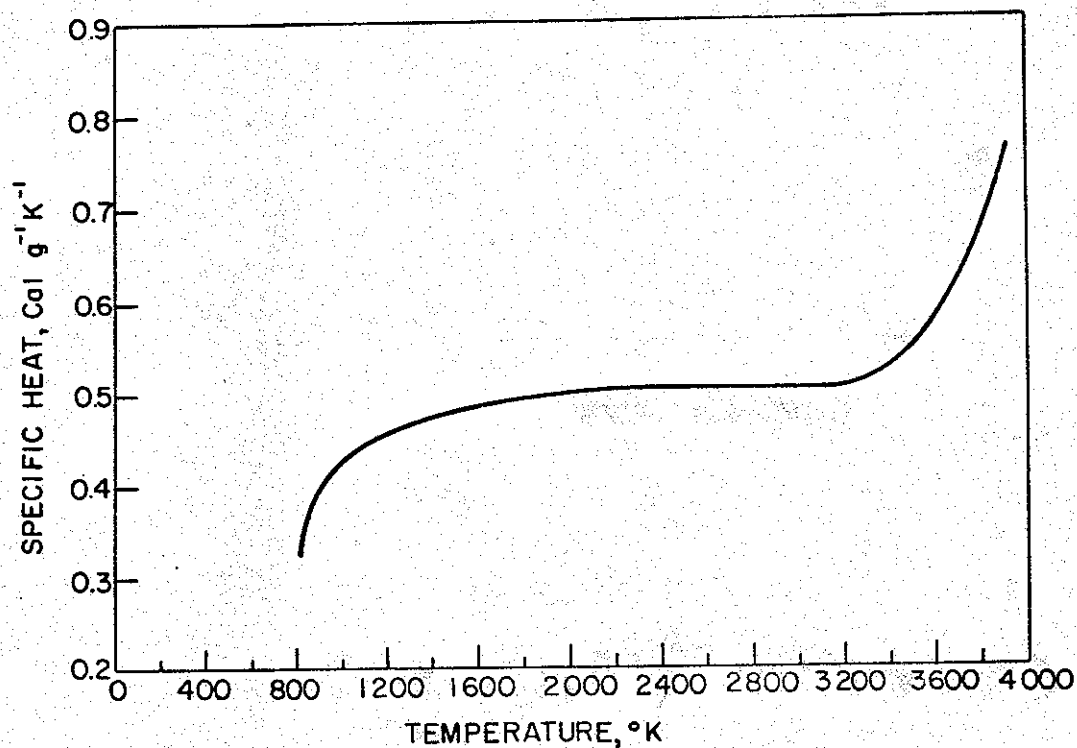

Figure 15. Specific Heat - Graphite Grade 3474D

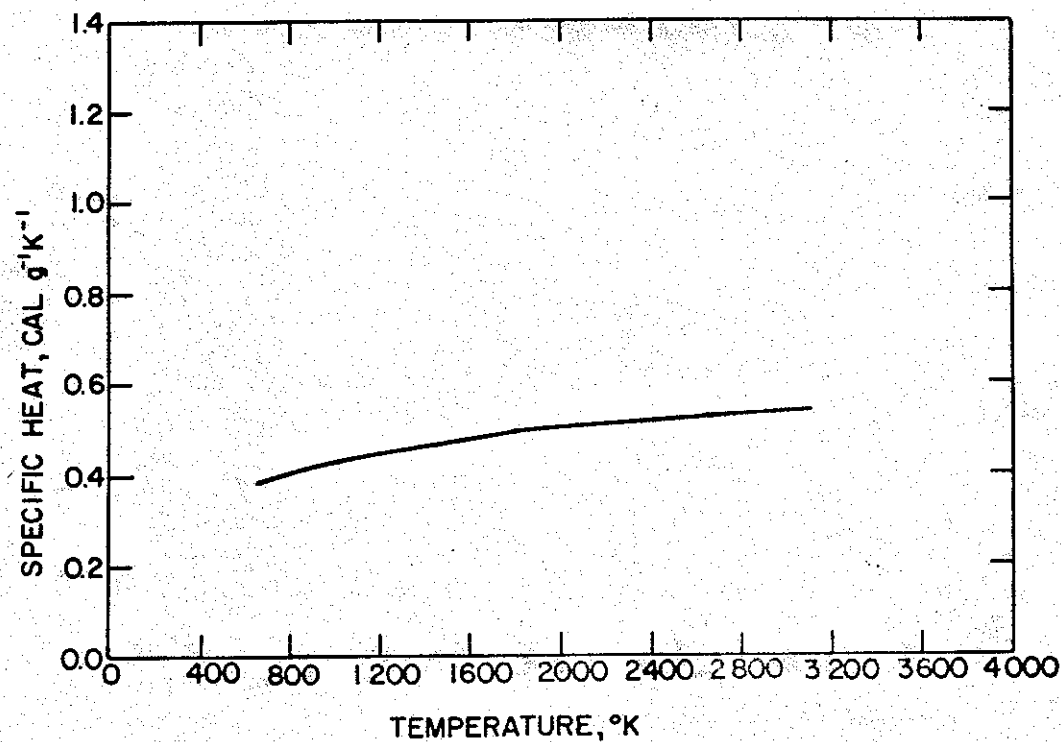

Figure 16. Specific Heat - Graphite Grade ATJ

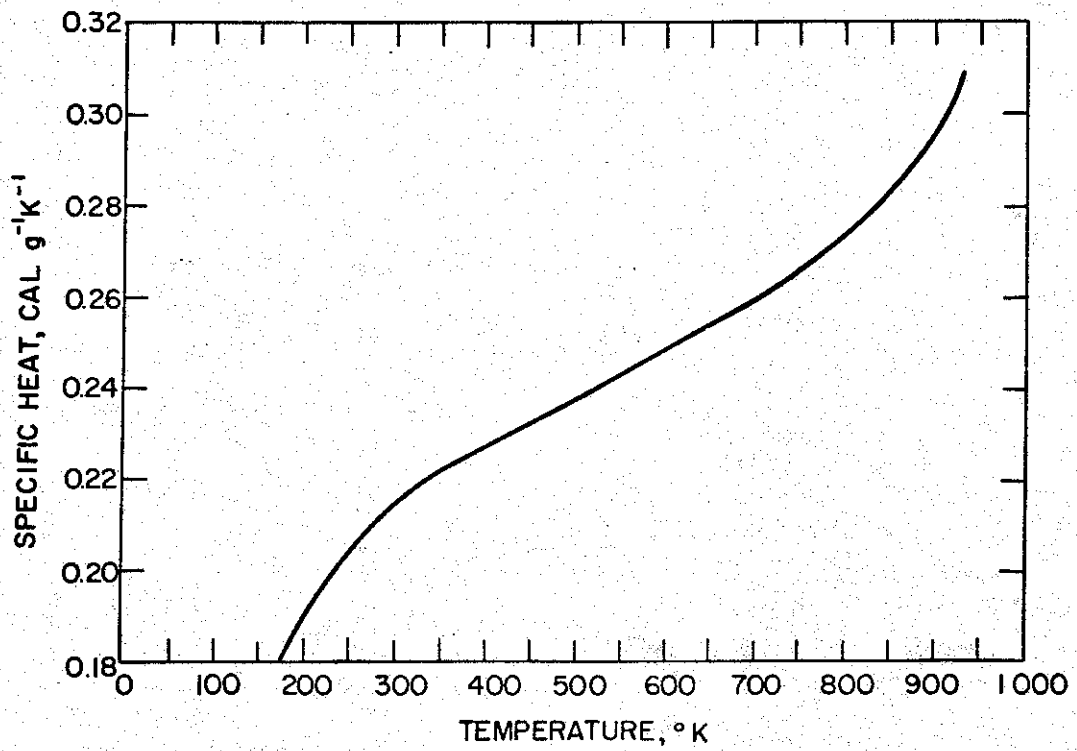

Figure 17. Specific Heat - Aluminum

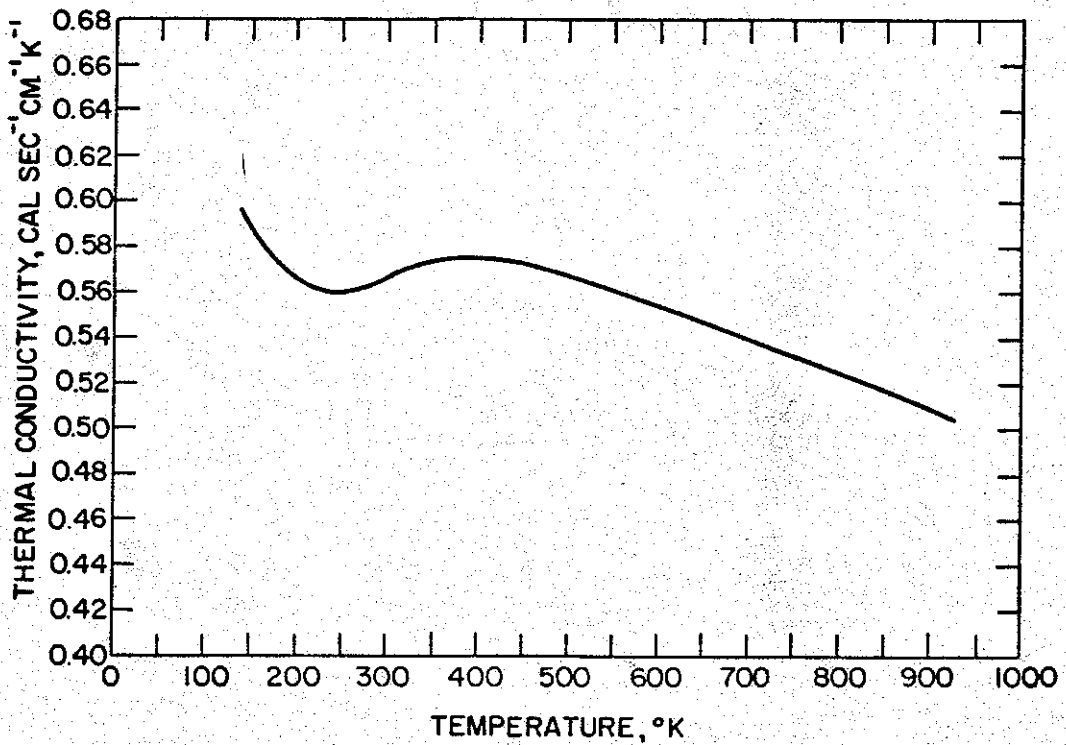

Figure 18. Thermal Conductivity - Aluminum

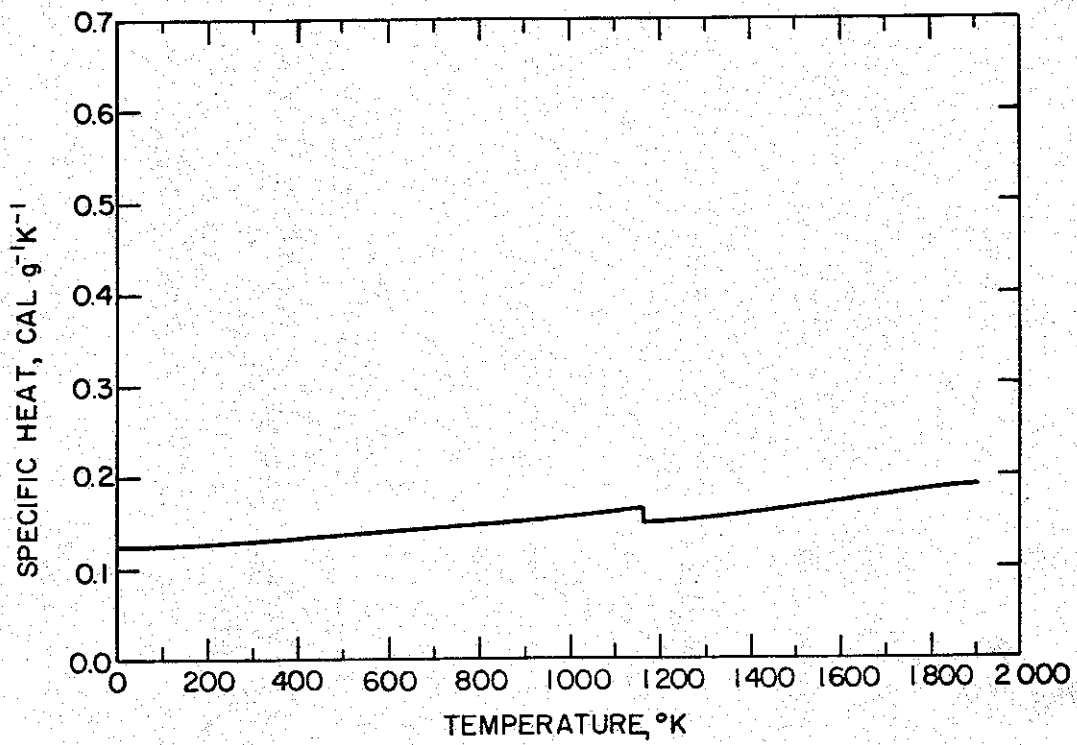

Figure 19. Specific Heat - Titanium

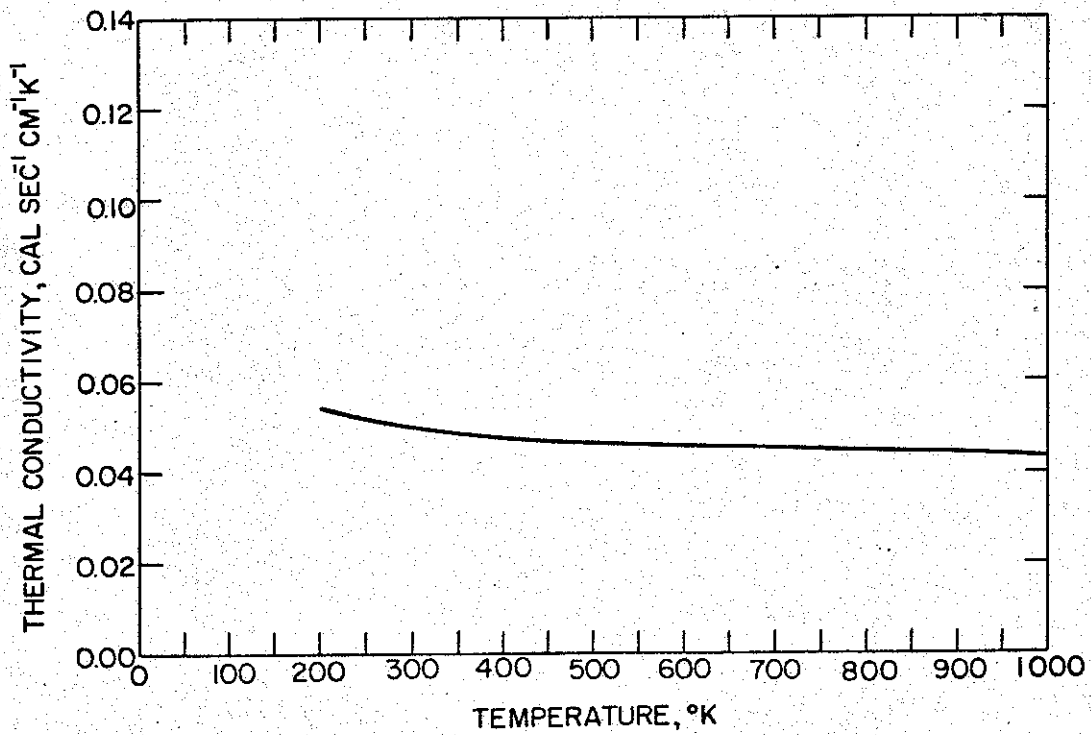

Figure 20. Thermal Conductivity - Titanium

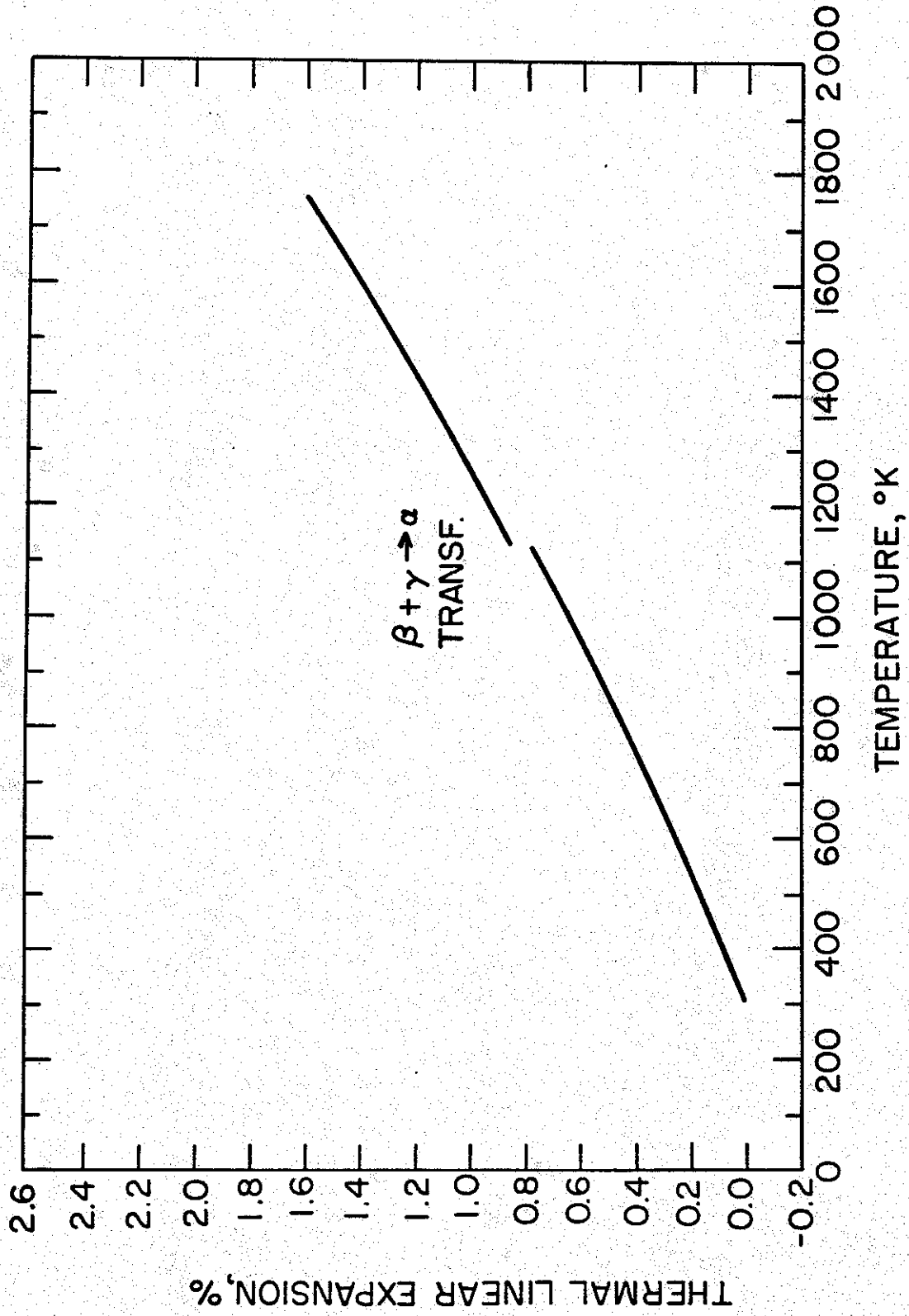

Figure 21. Thermal Linear Expansion - Titanium

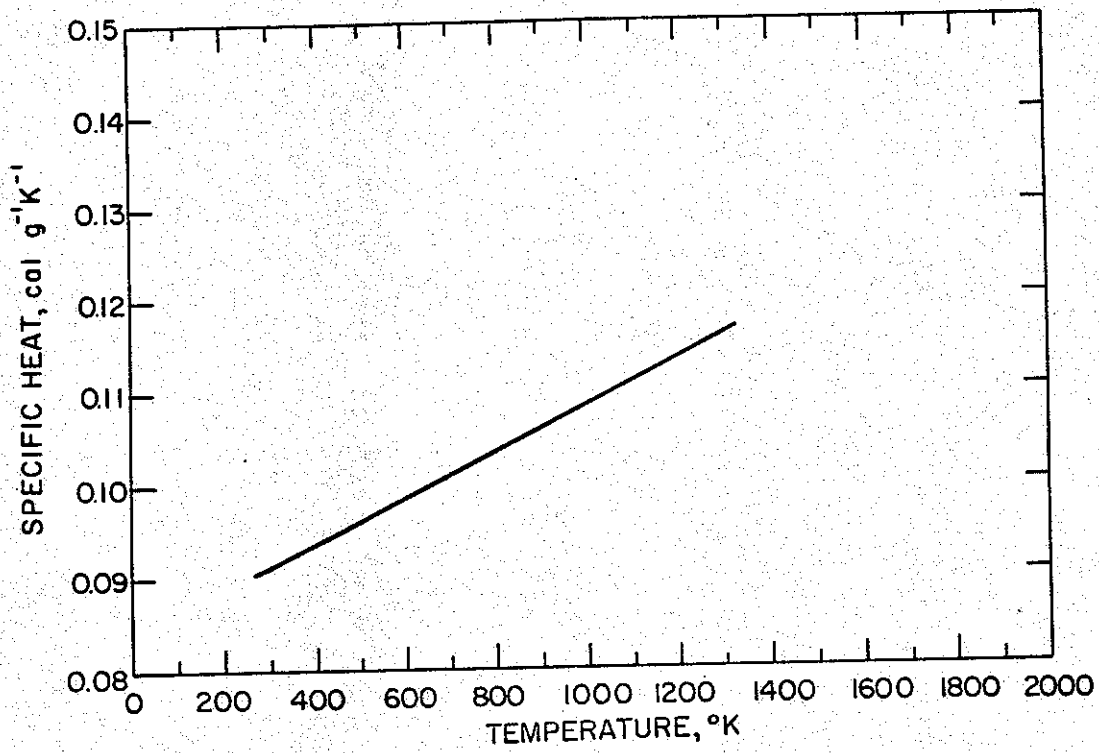

Figure 22. Specific Heat - Copper

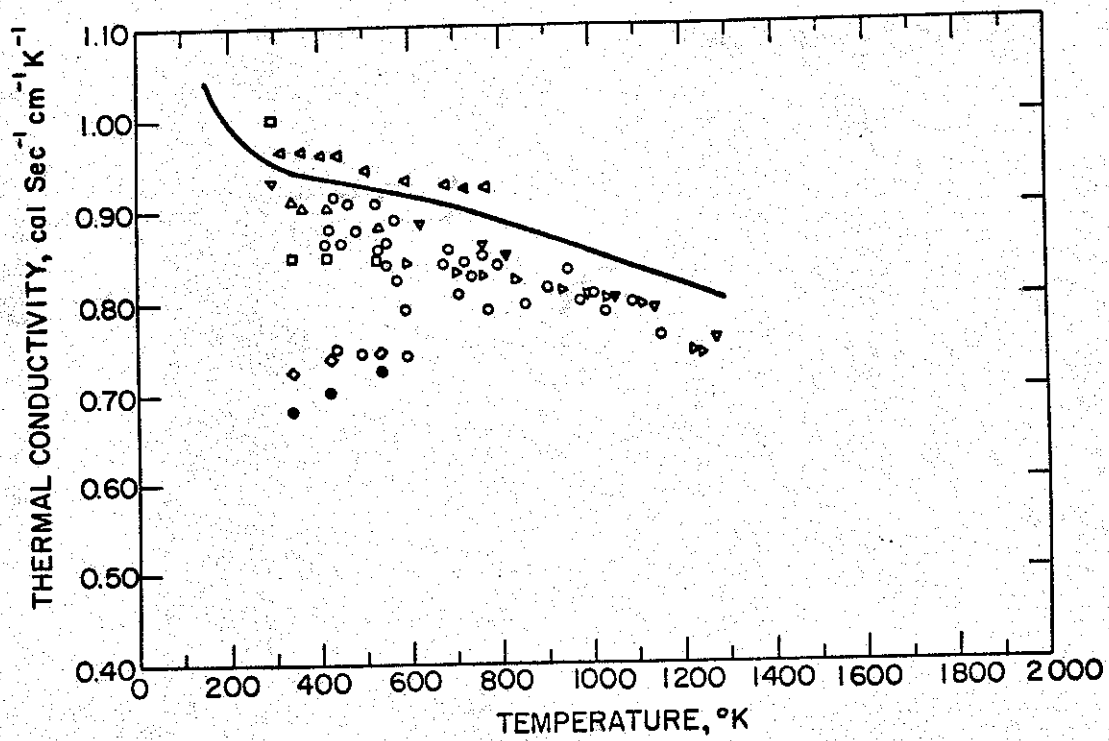

Figure 23. Thermal Conductivity - Copper

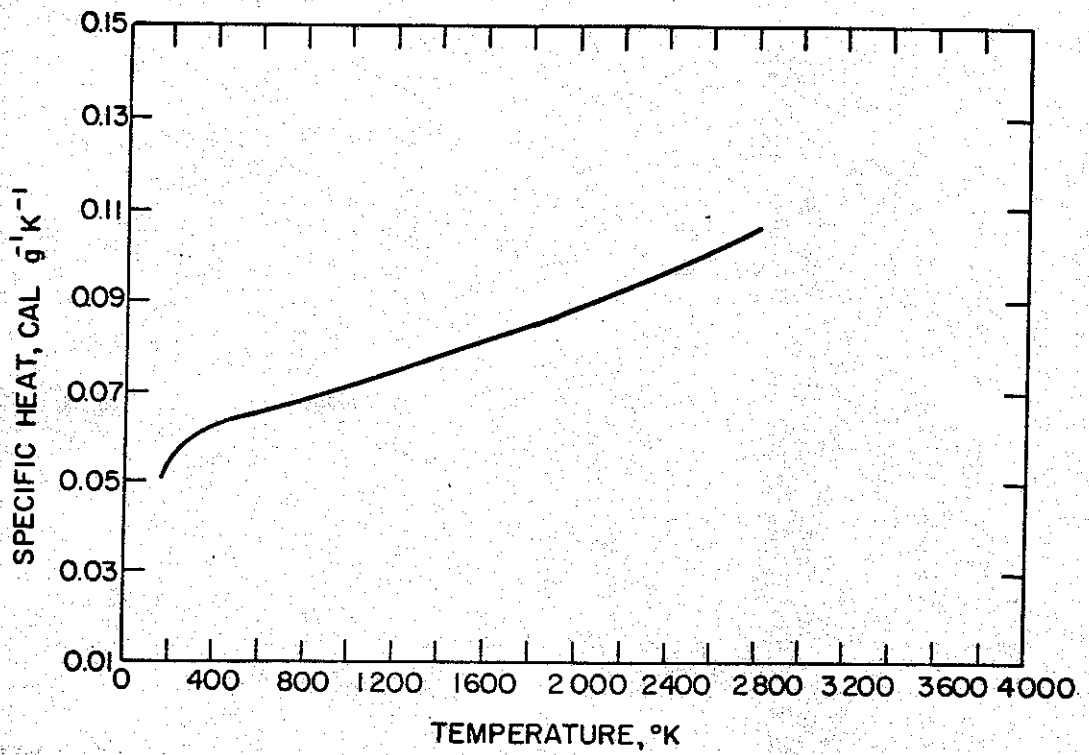

Figure 24. Specific Heat - Molybdenum

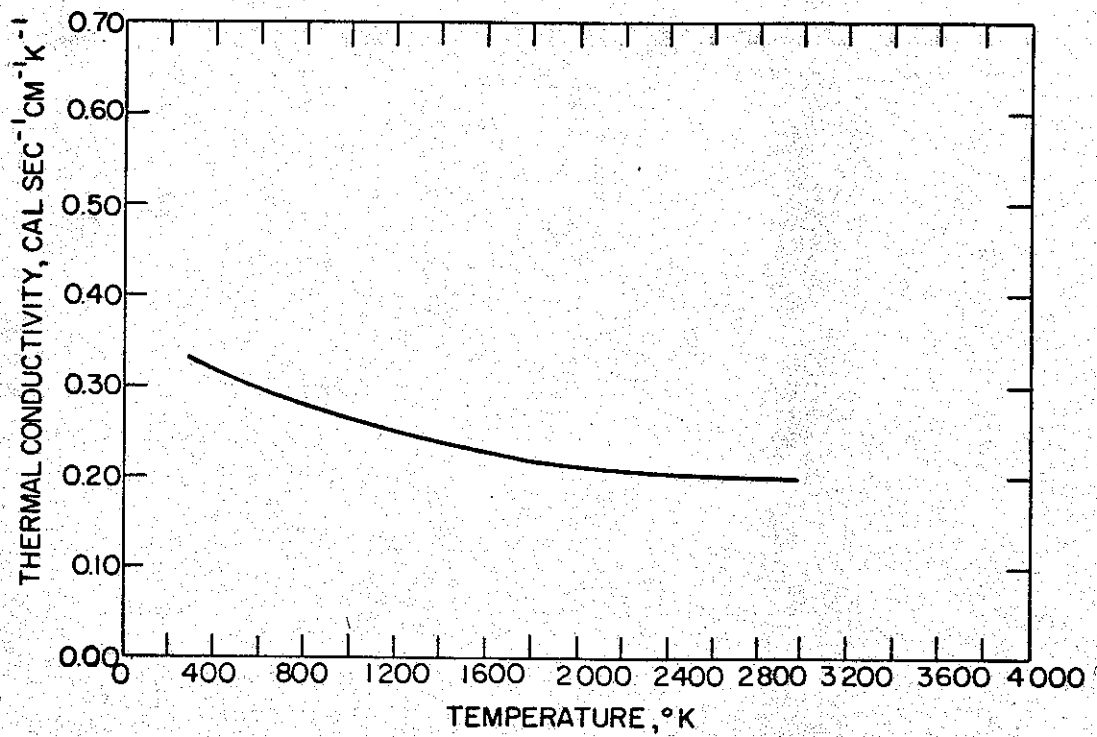

Figure 25. Thermal Conductivity - Molybdenum

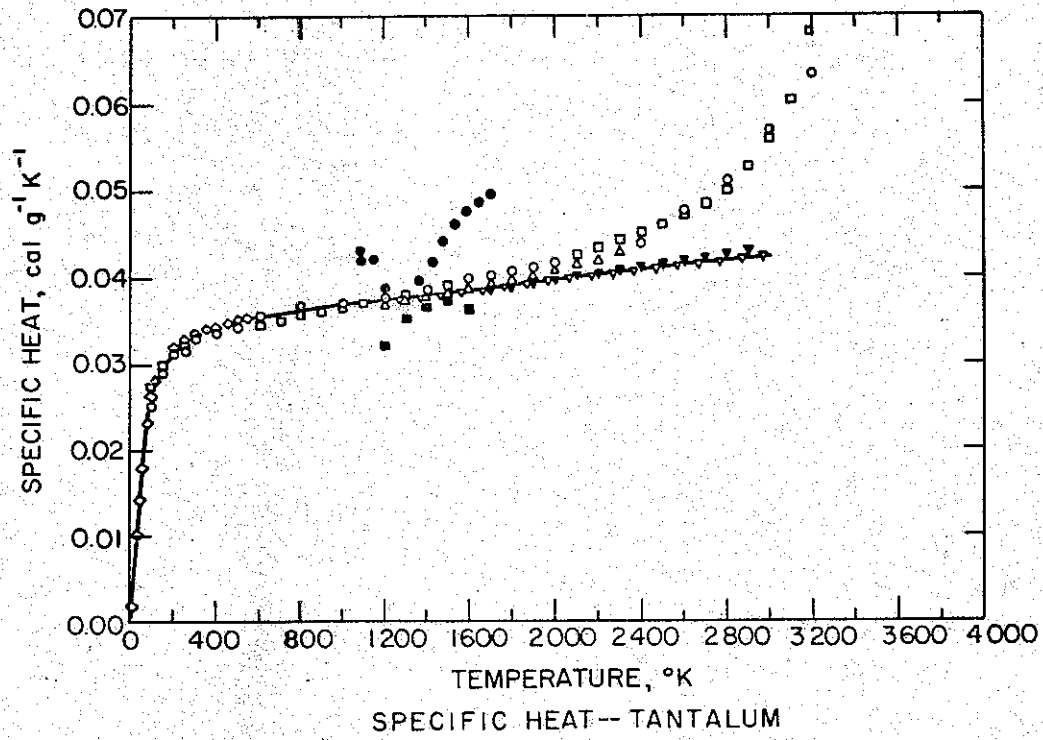

Figure 26. Specific Heat - Tantalum

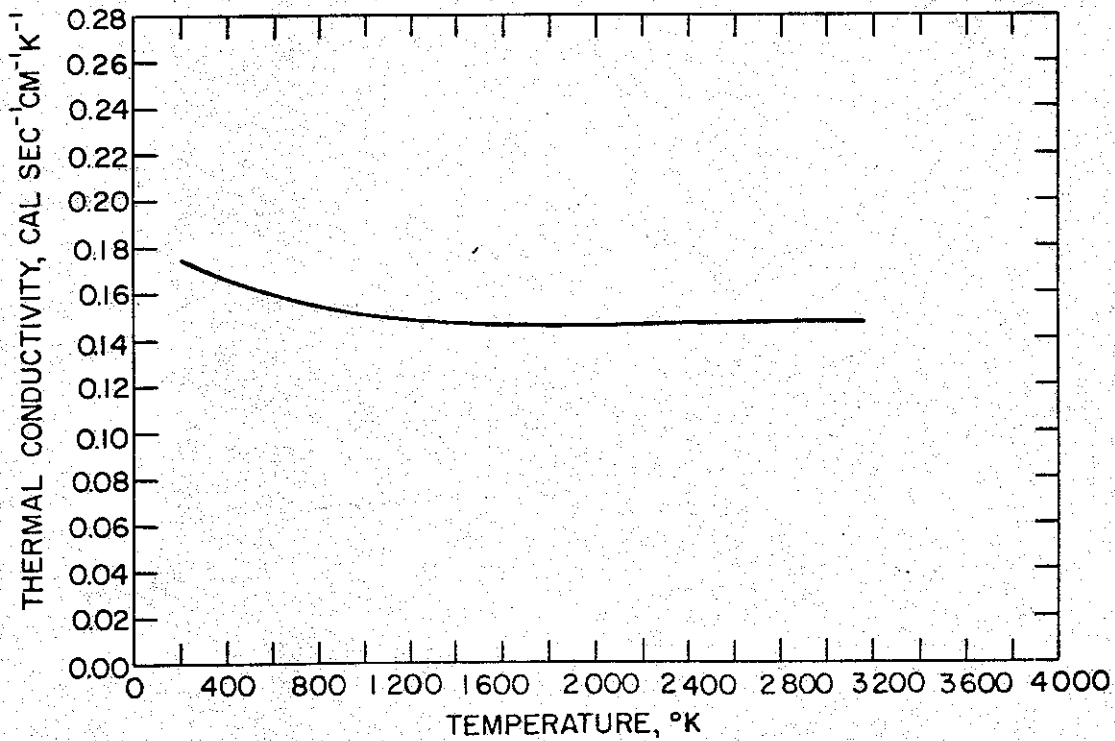

Figure 27. Thermal Conductivity - Tantalum

DISTRIBUTION:

A. Goodman, 1224
E. G. Coffee, 2322
A. E. Giddings, 2322
J. A. Hood, 2635
W. T. Corbett, 2635
D. H. Habing, 2635
J. E. Schwiner, 2635
B. D. Shafer, 2635
D. L. Weaver, 2635
G. J. Wilson, 2635
S. J. Buchsbaum, 5000
A. Narath, 5100
P. M. Beeson, 5113
L. K. Horning, 5113
L. C. Hebel, 5200
A. W. Snyder, 5220
R. M. Jefferson, 5221 (5)
F. A. Bailey, 5221
A. M. Chodorow, 5221
D. W. Dugan, 5221
J. E. Harness, 5221
P. J. Klaski, 5221
W. W. Rowe, 5221
R. L. Coats, 5222
F. Gonzales, 5222
W. H. McAtee, 5222
J. V. Walker, 5223
W. H. Buckalew, 5223
J. A. Halbleib, 5223
J. G. Kelly, 5223
L. D. Posey, 5223
R. L. Schuch, 5223
J. F. Schulze, 5223 (5)
A. Thom, 5223
G. C. Smith, 5224

O. L. Buchett, 5225
W. B. Gauster, 5225
F. C. Perry, 5225
F. C. Peterson, 5225
C. R. Mehl, 5230
E. H. Beckner, 5240
J. B. Gerardo, 5243
J. B. Toops, 5243
T. H. Martin, 5245
A. J. Barber, 5245
J. E. Boers, 5245
D. L. Johnson, 5245
D. Kelleher, 5245
F. W. Neilson, 5260
C. F. Bild, 5400
Technical File, 5400 (2)
D. W. Miller, 5411
R. Quinn, 5411
E. L. Amador, 7351
G. E. Chaffee, 7351
D. K. Dean, 8125
A. Gross, 8125
A. N. Blackwell, 8310
J. D. Plimpton, 9112
J. L. Benson, 9112
J. G. Prather, 9112
M. M. Conrad, 9121
R. S. Gillespie, 3411
W. J. Wagoner, 3413 (2)
G. C. McDonald, 3416
B. R. Allen, 3421
B. F. Hefley, 8232
C. H. Sproul, 3428-2 (15)

Is